



14.8 cu. ft. FRENCH DOOR REFRIGERATOR WITH BOTTOM FREEZER DRAWERS

Models:
FDRD152PL
FDRD153SS
LRFD15

User Manual

BEFORE USE, PLEASE READ AND FOLLOW ALL SAFETY RULES AND OPERATING INSTRUCTIONS.

*Write Model and Serial Numbers (on
back of unit) here:*

Felix Storch, Inc.
An ISO 9001:2015 registered company
770 Garrison Avenue
Bronx, NY 10474
www.summitappliance.com

TABLE OF CONTENTS

Appliance Safety	3
Important Safeguards	3-4
Installation Instructions	5-7
<i>Locating your Appliance</i>	5
<i>Leveling your Appliance</i>	5
<i>Disassembling and Reassembling the Freezer Drawer</i>	6-7
Operating your Appliance	8-9
<i>Control Panel</i>	8
<i>Controlling the Temperature</i>	8
<i>Glass Shelves and Door Racks</i>	9
<i>Drawers</i>	9
Cleaning and Care	10
<i>Exterior Cleaning</i>	10
<i>Interior Cleaning</i>	10
<i>Cleaning the Door Seals</i>	10
<i>Energy-Saving Tips</i>	10
Troubleshooting	11
Disposal	12
Limited Warranty	14

APPLIANCE SAFETY

Your safety and the safety of others are very important.

We have provided many important safety messages in this manual and on your appliance. Always read and obey all safety messages.



This is the Safety Alert Symbol. The symbol alerts you to potential hazards that can kill or injure you and others. All safety messages will follow the Safety Alert Symbol and either the words "DANGER" or "WARNING".



DANGER means that failure to heed this safety statement may result in severe personal injury or death.



WARNING means that failure to heed this safety statement may result in extensive product damage, serious personal injury, or death.

All safety messages will alert you about the potential hazard, tell you how to reduce the chance of injury, and let you know what can happen if the instructions are not followed.

IMPORTANT SAFEGUARDS



Before the appliance is used, it must be properly positioned and installed as described in this manual, so read the manual carefully. To reduce the risk of fire, electrical shock or injury when using the appliance, follow basic precautions, including the following:



- Plug into a grounded 3-prong outlet, do not remove grounding prong, do not use an adapter, and do not use an extension cord.
- Replace all panels before operating.
- It is recommended that a separate circuit serving only your appliance be provided. Use receptacles that cannot be turned off by a switch or pull chain.
- Never clean appliance parts with flammable fluids. These fumes can create a fire hazard or explosion. And do not store or use gasoline or other flammable vapors and liquids in the vicinity of this or any other appliance. The fumes can create a fire hazard or explosion.
- Before proceeding with cleaning and maintenance operations, make sure the power line of the unit is disconnected. Failure to do so can result in electrical shock or death.
- Do not connect or disconnect the electric plug when your hands are wet.
- Do not attempt to repair or replace any part of your appliance unless it is specifically recommended in this manual. All other servicing should be referred to a qualified technician.
- This appliance is CFC- and HFC-free and contains small quantities of Isobutane (R600a) which is environmentally friendly, but flammable. It does not damage the ozone layer, nor does it increase the greenhouse effect. Care must be taken during transportation and setting up of the appliance that no parts of the cooling system are damaged. Leaking coolant can ignite and may damage the eyes.
- In the event of any damage:
 - Avoid open flames and anything that creates a spark,
 - Disconnect from the electrical power line,
 - Air the room in which the appliance is located for several minutes, and
 - Contact the Service Department for advice.
- The more coolant there is in an appliance, the larger the room it should be installed in. In the event of a leakage, if the appliance is in a small room, there is the danger of combustible gases building up.

For every ounce of coolant at least 325 cubic feet of room space is required. The amount of coolant in the appliance is stated on the data plate on the back of the appliance. It is hazardous for anyone other than an Authorized Service Person to carry out servicing or repairs to this appliance.

- Take serious care when handling, moving, and using the appliance to avoid either damaging the refrigerant tubing or increasing the risk of a leak.

WARNING

FOLLOW WARNING CALLOUTS BELOW ONLY WHEN APPLICABLE TO YOUR MODEL

- This unit is intended FOR INDOOR USE ONLY.
- Use two or more people to move and install appliance. Failure to do so can result in back or other injury.
- To ensure proper ventilation for your appliance, at least 4 inches (100mm) of space should be kept between the back of the unit and the wall to allow proper air circulation to cool the compressor and condenser. Choose a well-ventilated area with temperatures above 60°F (16°C) and below 90°F (32°C) (The optimal operating range is between 72° and 78°F, or 23° to 26°C.) This unit must be installed in an area protected from the elements, such as wind, rain, water spray or drips.
- The appliance should not be located next to ovens, grills or other sources of high heat.
- Never place heavy objects or items containing water on top of the unit. Spilled water could deteriorate the insulation of electrical components and result in electrical leakage.
- The appliance must be installed with all electrical, water and drain connections in accordance with state and local codes. A standard electrical supply (115 V AC only, 60 Hz), properly grounded in accordance with the National Electrical Code and local codes and ordinances, is required.
- Do not throw items onto the shelves and do not place items totaling more than 65 lbs. on each shelf. The shelf could fall, possibly causing injury.
- Do not kink or pinch the power supply cord of the appliance.
- The size of the fuse (or circuit breaker) should be 15 amperes.
- It is important that the appliance be leveled in order to work properly. You may need to make several adjustments to level it.
- All installations must be in accordance with local plumbing code requirements.
- Make certain that the pipes are not pinched, kinked or damaged during installation.
- Check for leaks after connection.
- Never allow children to operate, play with or crawl inside the appliance.
- Do not allow anyone to hang from the door or climb onto the unit. The unit could tip over and fall, causing material damage and injury.
- Do not use solvent-based cleaning agents or abrasives on the interior. These cleaners may damage or discolor the interior.
- This appliance is intended for storage and display of beverages for sale. Use this appliance only for its intended purpose.
- Keep fingers out of the “pinch point” areas. Clearances between the doors and between the doors and cabinet are necessarily small. Be careful closing doors when children are in the area.

DANGER

Risk of child entrapment!

Child entrapment and suffocation are not problems of the past. Junked or abandoned appliances are still dangerous, even if they will “just sit in the garage a few days”.

Before discarding your old refrigerator:

- *Take off the doors*
- *Leave the shelves in place so that children may not easily climb inside.*

- SAVE THESE INSTRUCTIONS -

INSTALLATION INSTRUCTIONS

- For proper installation, this refrigerator must be placed on a level surface of hard material that is the same height as the rest of the flooring. The surface should be strong enough to support a fully loaded refrigerator.
- The rollers are not casters and should only be used for forward or backward movement. Moving the refrigerator sideways may damage your floor and the rollers.

Locating your Appliance

- In order to improve the efficiency of the cooling system and save energy, it is necessary to maintain good ventilation around the appliance for the dissipation of heat. For this reason, sufficient clear space should be available around the refrigerator.
- Keep the appliance out of direct sunlight, rain, or frost. Make the appliance is placed away from heat sources, such as stoves, fires, or heaters.
- Avoid placing the appliance in a dry place to avoid moisture.

NOTE: Before connecting the appliance to the power source, let it stand upright for four hours, to allow the refrigerant to flow back into the compressor.

- This appliance is intended for freestanding installation. Please allow these minimum clearances to ensure the best operation and proper ventilation:
 - 1" on the side (and even more space to allow the doors to open wider than their width to make it easier to remove shelves and storage bins)
 - 1" at the rear
 - 1" at the top

CAUTION: Be sure that airflow at the bottom of the appliance is not blocked.

- Place the appliance in a room with an ambient temperature between 50°F and 90°F. The refrigerator may not work properly if it is left in temperatures above or below the indicated temperature range.

Leveling your Appliance

For sufficient leveling and air circulating in the lower rear area of your appliance, the bottom feet may be adjusted. You may adjust them manually by hand or by using a suitably sized wrench. To allow the doors to self-close, tilt the appliance backwards by 10-15mm (1/3" – 2/3").

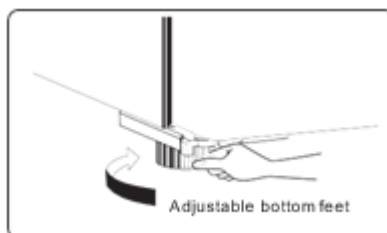

NOTE: You may lay the refrigerator on its back in order to gain access to the base, you should rest it on soft foam packaging or similar material to avoid damaging the backboard of the refrigerator.

Disassembling and Reassembling the Freezer Drawer

- The freezer section of your appliance contains an upper and lower drawer, two trays, and an ice box.
- The drawers are removeable, and should you desire to remove the drawers to help move your appliance, follow the steps below:

Removing the Freezer Drawer

1. Open the freezer door. Pull the adjusting block (A) of the drawer glides, and pull the freezer drawer door out as far as it will go.

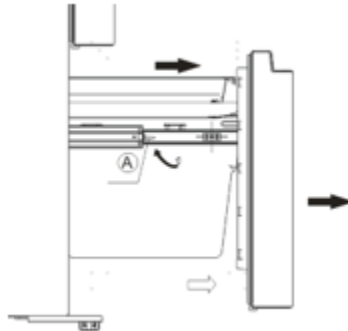

2. Remove the tray (B) by lifting it up, and out, as shown below.



3. Remove the freezer drawer by lifting it up and out of the unit.

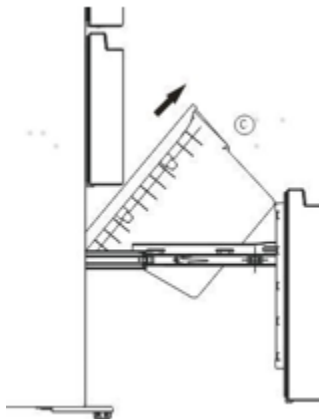

Re-assembling the Freezer Drawer

Once your appliance is placed in its final location, re-assemble the drawer in the reverse order you disassembled it.

1. Insert the drawer down and into your appliance, in the direction of the arrow below.

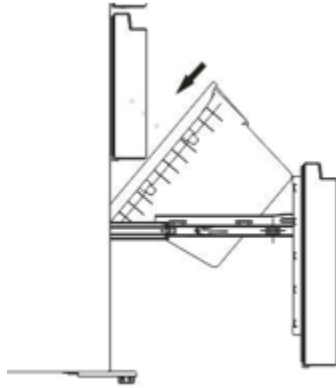

2. Put the tray on top of the drawer, and push it inward to ensure the tray's rollers are set on the freezer liner.

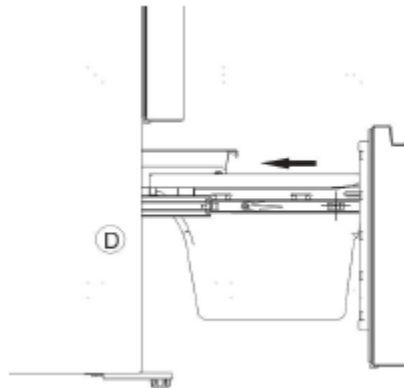

3. Push the freezer door closed.

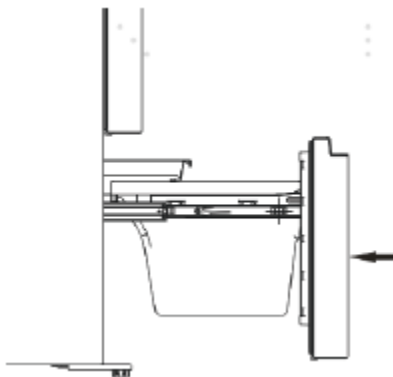

OPERATING YOUR APPLIANCE

- When your appliance is powered on for the first time, the temperature control panel will illuminate.
- If no buttons are pressed, and the doors are closed, the control panel will turn off after 60 seconds.

Control Panel

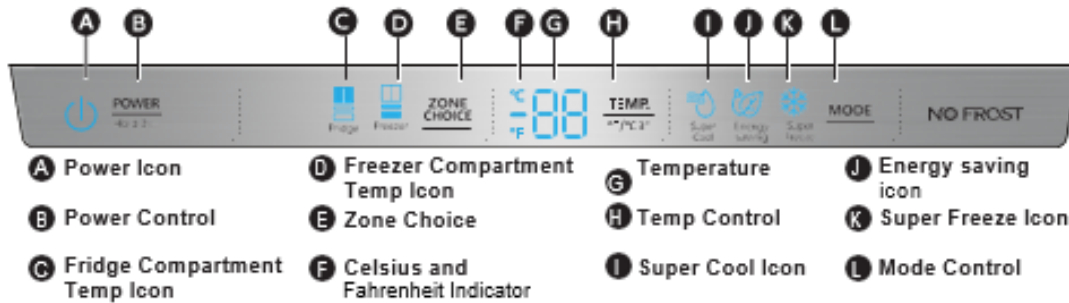

Switching Between Celsius and Fahrenheit

Press and hold TEMP for three seconds to toggle the display between Celsius and Fahrenheit.

Controlling the Temperature

- Press POWER for three seconds to turn the power on. Once on, press POWER for three seconds to turn the power off. The display will show “OFF.”

NOTE: Setting the temperature of the appliance will set the average temperature. The exact temperature may vary slightly depending on how much food is placed inside, how often the doors are opened, and ambient room temperature.

Setting the Refrigerator Temperature

- Press ZONE until the Fridge icon  is illuminated.
- When illuminated, press TEMP to cycle through the temperature setting each time the button is pressed, from 46°F to 36°F (8°C to 2°C).

NOTE: Each press of the TEMP button advances the setting by one degree.

Setting the Freezer Temperature

- Press ZONE until the Freezer icon  is illuminated.
- When illuminated, press TEMP to cycle through the temperature setting each time the button is pressed, from 7°F to -11°F (-14°C to -24°C).

NOTE: Each press of the TEMP button advances the setting by one degree.

Super Cool



- The Super Cool function refrigerates your food faster.
- Press MODE to select the Super Cool function. The  will be illuminated.
- The refrigerator temperature will be set to 36°F (2°C) for approximately three hours, after which, the Super Cool function will turn off, and the temperature will return to the previously set temperature.

Super Freeze



- Super Freeze will quickly lower the temperature of the freezer to freeze food faster.
- Press MODE to select the Super Freeze function. The  will be illuminated.
- The freezer temperature will be set to -11°F for approximately 52 hours, after which, the Super Freeze function will turn off, and the temperature will return to the previously set temperature.
- Press TEMP to manually turn off Super Freeze and return your freezer to the previously set temperature.

NOTE: It is not recommended to store bottles or can in the freezer when using Super Freeze mode, as they may explode.

Energy Saving



This function reduces the energy consumption of the appliance, when you are away and not using the appliance regularly.

- Press MODE until the energy saving icon is illuminated.
- The appliance will be automatically set to 43°F(6°C) in the refrigerator and 1°F(-17°C) in the freezer.
- Press TEMP to turn off Energy Saving mode and return the appliance to its previously set temperatures.

Open Door Alarm

If the refrigerator door is open longer than 2 minutes, the control panel will display “dr,” and an alarm will sound. To turn off the alarm, close the door completely.

Glass Shelves and Door Racks

- The refrigerator compartment comes with four glass shelves and several door racks, which can be placed at different heights, according to your needs.
- Pull the door racks straight up to remove.
- To adjust the interior shelves:
 1. Remove any food stored on the shelf.
 2. Gently pull the shelf forward until it clears the interior shelf guides.
 3. When replacing a shelf, make sure there are no objects behind it, and gently push the shelf all the way back into place.

NOTE: All the shelves are removable for cleaning.

Drawers

The drawers are mounted on telescopic extension slides, and can be removed by pulling the drawers out as far as they can go, lifting the tray out, and lifting the front of the drawer until the back released from the slides.

CLEANING AND CARE

CAUTION: Turn the appliance off and unplug the appliance before cleaning to reduce the risk of electrical shock.

It is recommended the appliance be cleaned every two months.

Exterior Cleaning

- Wipe the control panel with a clean, soft cloth.
- Spray water onto a clean, soft cloth, instead of spraying directly onto the appliance to ensure an even distribution of moisture.
- Clean the doors, handles, and cabinet surfaces with a mild detergent, and then wipe dry with a soft cloth.

CAUTION: Do NOT use sharp objects to clean the exterior, as they are likely to scratch the surface. Do NOT use thinner, car detergent, Clorox, ethereal oil, abrasive cleaners, or organic solvents such as Benzene for cleaning. These materials may damage the surface of the appliance or cause fire.

Interior Cleaning

- You should clean the appliance interior regularly. It will be easier to clean when food stocks are low. Wipe the inside of the fridge freezer with a weak solution of bicarbonate of soda, and then rinse with warm water using a wrung-out sponge or cloth. Wipe completely dry before replacing the shelves and baskets. Thoroughly dry all surfaces and removable parts.
- Although this appliance automatically defrosts, a layer of frost may occur on the freezer compartments and interior walls, if the freezer door is opened frequently or kept open too long. If the frost becomes too thick, choose a time when the supply of stored food is low, and follow these steps:
 1. Remove existing food and accessories baskets, unplug the appliance from the mains power and leave the doors open. Ventilate the room thoroughly to accelerate the thawing process.
 2. When defrosting is completed, clean your freezer as described above.

CAUTION: Don't use sharp objects to remove frost from the freezer compartment. Only after the interior is completely dry should the appliance be switched back on and plugged back into the mains socket.

Cleaning the Door Seals

Take care to keep door seals clean. Sticky food and drinks can cause seals to stick to the cabinet and tear when you open the door. Wash seal with a mild detergent and warm water. Rinse and dry it thoroughly after cleaning.

NOTE: Make sure the door seals are completely dry before turning the appliance back on.

Energy-Saving Tips

- Try to avoid keeping the doors open for long periods of time.
- Ensure the appliance is located away from any sources of heat, such as direct sunlight, an electric oven, etc.
- Don't set the temperature colder than necessary.
- Wait for food to cool before storing.
- Place the appliance in a well-ventilated, humidity free room.

TROUBLESHOOTING

If you experience a problem with your appliance or are concerned that the appliance is not functioning correctly, you can carry out some easy checks before calling for service, please see below.

Problem	Possible Cause and Solution
The appliance is not working properly.	Check whether the power cord is plugged into the power outlet properly.
	Check the fuse or circuit of your power supply, and replace it, if necessary.
	It is normal that the freezer is not operating during the defrost cycle, or for a short time after the appliance is switched on to protect the compressor.
Odors emitting from the compartments.	The interior may need to be cleaned.
	Some food, containers, or wrapping may cause odors.
The appliance is making too much noise.	The sounds below are normal: <ul style="list-style-type: none"> • The compressor operating noises. • Air movement noise from the small fan motor in the freezer compartment or other compartments. • Gurgling sounds similar to water boiling. • Popping noises made during automatic defrosting. • Clicking noise before compressor starts.
	Other unusual noises may be caused by the following reasons and may need to be checked: <ul style="list-style-type: none"> • The cabinet is not level. • The back of the appliance touches the wall. • Bottles or containers have fallen or are rolling.
The motor runs continuously.	It is normal to frequently hear the sound of the motor, and it will run more in the following circumstances: <ul style="list-style-type: none"> • The temperature is set colder than necessary • A large quantity of warm food has recently been stored in the appliance. • The ambient temperature where the appliance is located is too high. • The doors are kept open too long or is opened too often. • After installing the appliance or if the appliance has been turned off for an extended period.
A layer of frost occurs in the compartment.	<ul style="list-style-type: none"> • Check that the air outlets are not blocked by food and ensure food is placed in the appliance to allow sufficient ventilation. • Ensure the door is fully closed. To remove frost, please refer to the "Cleaning and Care" section.
The temperature inside is too warm.	You may have left the doors open too long or too frequently, the doors are kept open by some obstacle, or the appliance is located with insufficient clearance at the sides, back, and top
The temperature inside is too cold.	Increase the temperature by following the "Control Panel" section
The doors can't be easily closed.	Check whether the top of the refrigerator is tilted back by 10-15mm (1/3-2/3") to allow the doors to self-close or if something is preventing the doors from closing.

If you've checked the table above and find that you still need help with your refrigerator or freezer, call our Customer Service facility at **800-932-4267** between 9:00AM and 5:00PM ET. We will do our best to answer your questions.

DISPOSAL

CAUTION: It is prohibited to dispose of this appliance as household waste.

Packaging materials

Packaging materials with the recycle symbol are recyclable. Dispose of the packaging into a suitable waste collection container to recycle it.

Before disposal of the appliance

1. Pull out the mains plug from the mains socket.
2. Cut off the power cord and discard with the mains plug.

Correct Disposal of this Product	
	<p>This symbol on the product or its packaging indicates that this product may not be treated as household waste. Instead, it should be taken to the appropriate waste collection point for the recycling of electrical and electronic equipment. By ensuring this product is disposed of correctly, you will help prevent potential negative consequences for the environment and human health, which could otherwise be caused by the inappropriate waste handling of this product. For more detailed information about the recycling of this product, please contact your local council, your local household waste disposal service, or the shop where you purchased the product.</p>

NOTES

LIMITED WARRANTY

ONE-YEAR LIMITED WARRANTY

Within the 48 contiguous United States, for one year from the date of purchase, when this appliance is operated and maintained according to instructions attached to or furnished with the product, warrantor will pay for factory-specified parts and repair labor to correct defects in materials or workmanship. Service must be provided by a designated service company. Outside the 48 states, all parts are warranted for one year from manufacturing defects. Plastic parts, shelves and cabinets are warranted to be manufactured to commercially acceptable standards, and are not covered from damage during handling or breakage.

5-YEAR COMPRESSOR WARRANTY

1. The compressor is covered for 5 years.
2. Replacement does not include labor.

ITEMS WARRANTOR WILL NOT PAY FOR:

1. Service calls to correct the installation of your appliance, to instruct you how to use your appliance, to replace or repair fuses or to correct wiring or plumbing.
2. Service calls to repair or replace appliance light bulbs or broken shelves. Consumable parts (such as filters) are excluded from warranty coverage.
3. Damage resulting from accident, alteration, misuse, abuse, fire, flood, acts of God, improper installation, installation not in accordance with electrical or plumbing codes, or use of products not approved by warrantor.
4. Replacement parts or repair labor costs for units operated outside the United States.
5. Repairs to parts or systems resulting from unauthorized modifications made to the appliance.
6. The removal and reinstallation of your appliance if it is installed in an inaccessible location or is not installed in accordance with published installation instructions.

DISCLAIMER OF IMPLIED WARRANTIES - LIMITATION OF REMEDIES

CUSTOMER'S SOLE AND EXCLUSIVE REMEDY UNDER THIS LIMITED WARRANTY SHALL BE PRODUCT REPAIR AS PROVIDED HEREIN. IMPLIED WARRANTIES, INCLUDING WARRANTIES OF MERCHANTABILITY OR FITNESS FOR A PARTICULAR PURPOSE, ARE LIMITED TO ONE YEAR. WARRANTOR SHALL NOT BE LIABLE FOR INCIDENTAL OR CONSEQUENTIAL DAMAGES. SOME STATES DO NOT ALLOW THE EXCLUSION OR LIMITATION OF INCIDENTAL OR CONSEQUENTIAL DAMAGES, OR LIMITATIONS ON THE DURATION OF IMPLIED WARRANTIES OF MERCHANTABILITY OR FITNESS, SO THESE EXCLUSIONS OR LIMITATIONS MAY NOT APPLY TO YOU. THIS WARRANTY GIVES YOU SPECIFIC LEGAL RIGHTS AND YOU MAY ALSO HAVE OTHER RIGHTS, WHICH VARY FROM STATE TO STATE.



WARNING: This product can expose you to chemicals including Nickel (Metallic) which is known to the State of California to cause cancer.

For more information go to www.P65Warnings.ca.gov

Note: Nickel is a component in all stainless steel and some other metal compositions.

Felix Storch, Inc.
Summit Appliance Division
An ISO 9001:2015 registered company
770 Garrison Avenue
Bronx, NY 10474
www.summitappliance.com

SUMMIT®

For parts and accessory ordering,
troubleshooting and helpful hints, visit:
www.summitappliance.com/support